

BY SYNARGY®
SMART
COMFORT

ROCCO

MASSAGE CHAIR



QUICK START GUIDE &
OPERATING INSTRUCTIONS

QUICK START GUIDE

1

Remove your shoes and sit into the chair. You can press down with your feet to extend the footrest length. It is recommended to use the massage chair without wearing jewellery or watches.

2

Press the power button on the remote control, and allow the chair 20-30 seconds to power on. Place your arms inside the arm rests.

3

The chair will automatically enter an automatic massage mode if no buttons are pressed. You can enjoy this mode as it is, or read these operating instructions to learn about more advanced operation.

BASIC CONTROLS

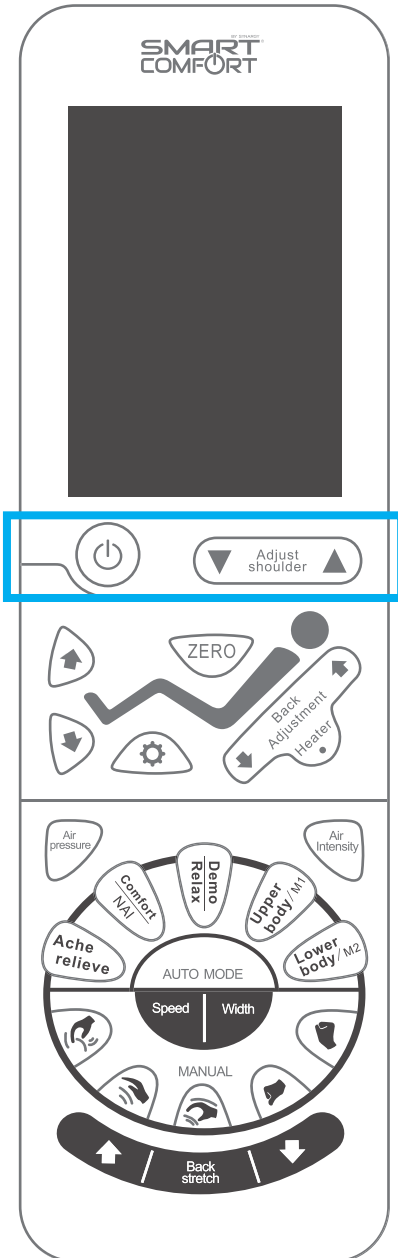

- **Power button** turns the chair on & off. Wait 20-30 seconds for the chair to power on, then select a mode on the remote control. The chair will automatically enter Comfort auto mode if no options are selected
- **Shoulder position up & down arrows** adjust how far up the shoulders the rollers will travel during shoulder focused movements

CHAIR POSITION CONTROLS

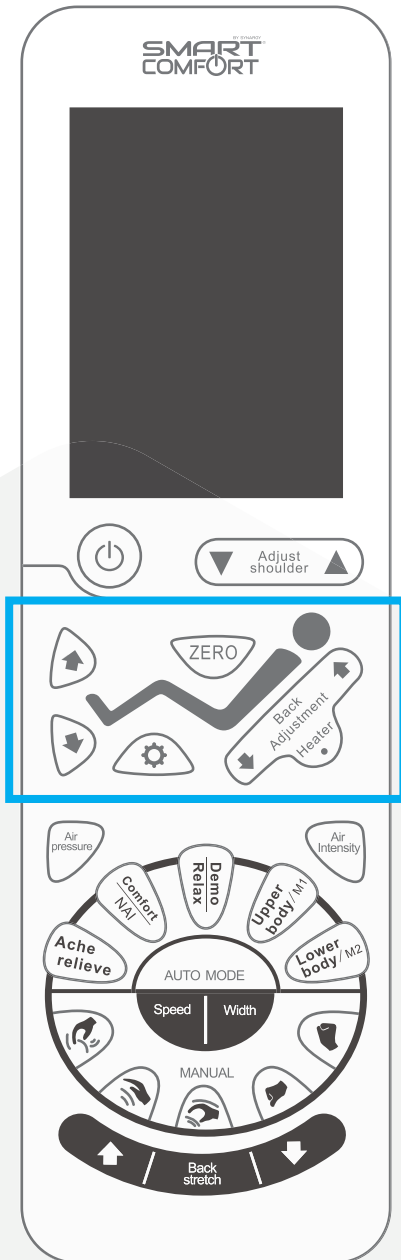

Used for selecting the position of the chair:

- **Up arrow button** will raise the footrest upwards. Press and hold to adjust position
- **Down arrow button** will lower the footrest downwards. Press and hold to adjust position
- **Gear button** will change the foot roller speed between 3 levels or off
- **Zero button** moves the chair into zero gravity horizontal position, which has two levels - press button again to recline further back. Press again to return to regular position
- **Back Adjustment** up and down arrows change the amount of chair recline. Press and hold to adjust
- **Heater button** toggles the backrest heat on off. (Approx 3 minutes to max temperature)

AUTOMATIC MODE CONTROLS

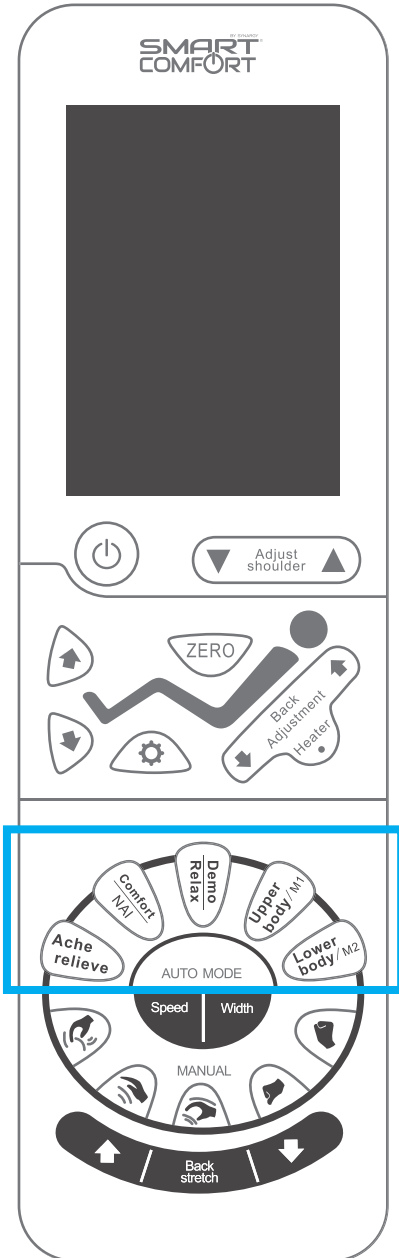

Used for selecting the following automatic massage modes:

- **Ache relieve** is a gentle mode where the chair continuously tilts back and forward, with a focus on the lower and middle back
- **Comfort** is a full body mode with a focus on the upper back, and uses less shoulder airbags
- **Relax** is a gentle mode that targets the whole body
- **Demo** showcases all main massage functions of the chair in a quick 5 minute mode (press and hold Relax/Demo button for 3 seconds then release to access demo mode.)
- **Upper body** focuses on the upper body
- **Lower body** focuses on the lower body

AIRBAG CONTROLS

Used for controlling the following functions during automatic modes or manual operation:



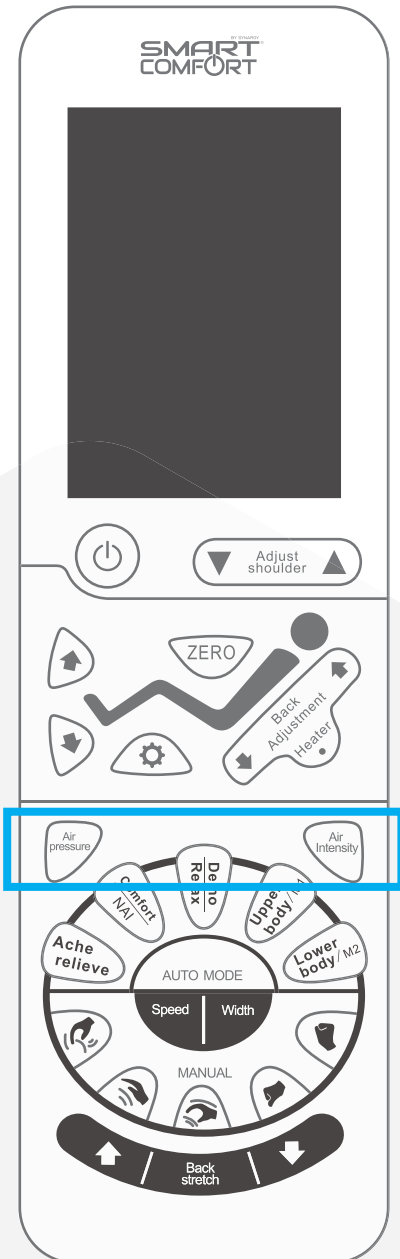

- **Air pressure** toggles airbag function between: arms, feet, arms + feet or off.
- **Air Intensity** adjusts the intensity of pressure from the airbags.

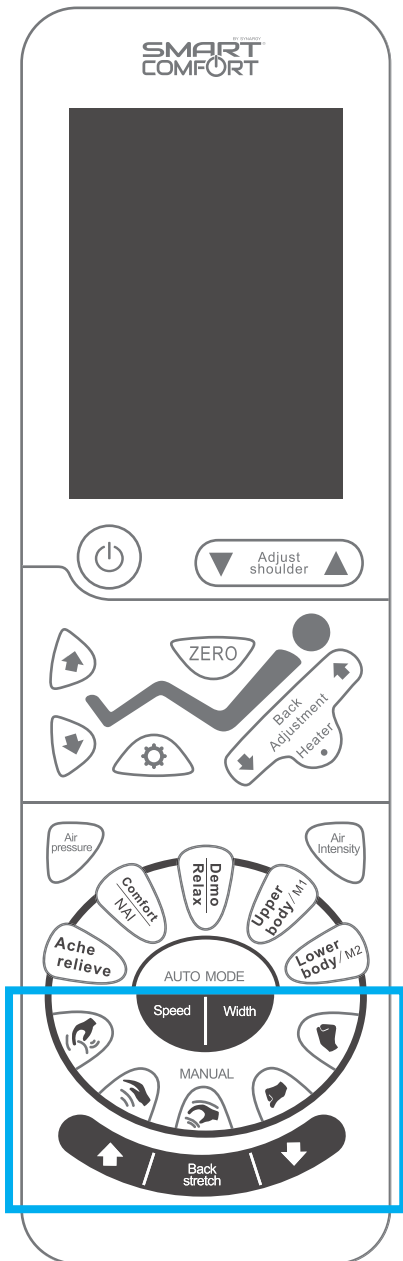





MANUAL MODE CONTROLS



- Shortcut buttons for back roller massage modes:

-  kneading
-  tapping
-  kneading + tapping
-  shiatsu
-  knocking

- **Speed** adjusts the speed of the massage rollers movement
- **Width** adjusts the width between rollers during shiatsu, tapping or knocking modes
- **Back stretch** toggles back massage modes between:

-  **H0** fixed position back massage
-  **H1** short area back massage
-  **H2** entire back massage
-  **H3** upper back massage
-  **H4** lower back massage

- **The arrows** either side of back stretch will adjust the position of rollers during H0 and H1 modes

MEMORY FUNCTION

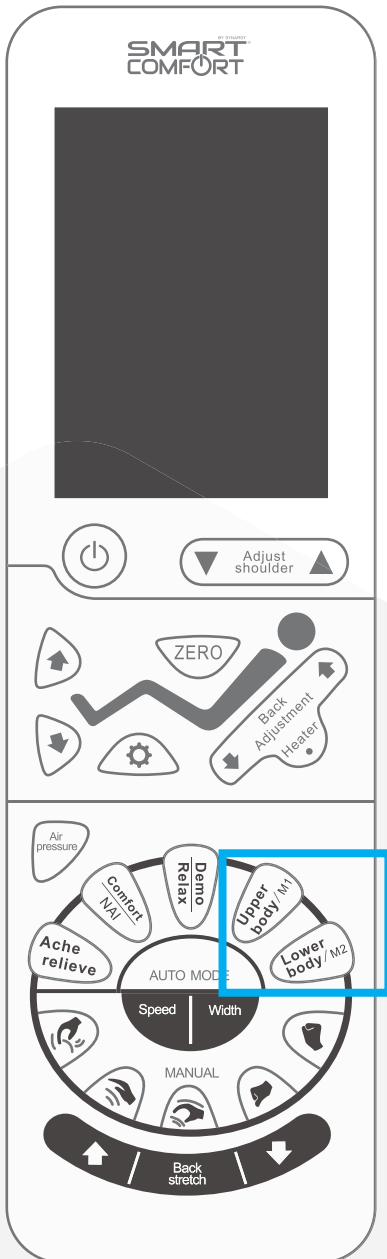

To save the current massage settings, press the power button to turn the chair off, and press & hold **M1** or **M2** for 3 seconds while the screen is flashing “Memory.”

When the chair is on, press and hold **M1** or **M2** for 3 seconds to load the saved massage settings.

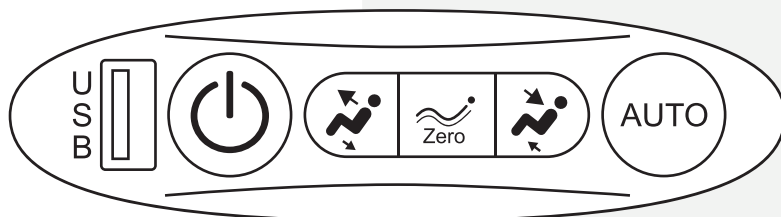

ARMREST CONTROL PANEL



- **USB port** can be used to charge your smartphone
- **Power button** turns the chair on & off
- **AUTO button** will cycle through the automatic modes
-  **button** will recline the chair back and raise the footrest, press and hold to adjust position
-  **button** moves the chair into zero gravity horizontal position which has two levels - press button again to recline further back. Press again to return to regular position
-  **button** will raise the chair upright and lower the footrest, press and hold to adjust position

BLUETOOTH AUDIO

To play music or other audio through the bluetooth speakers, go to the Bluetooth settings menu on your phone or device.

Search for a new device, look for “Smart Comfort 0000” or similar and choose ‘connect’ or ‘pair’.

You can then play music using your regular media player app.

ROCCO MASSAGE CHAIR

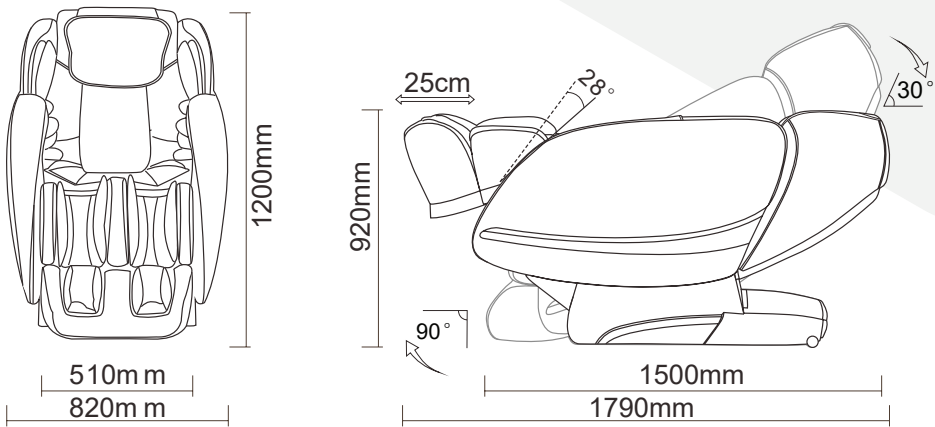

Keep at least 275mm of clear space between the chair backrest and nearby walls or furniture to ensure there is no contact with any items when chair is fully reclined.

Health and Safety Warnings: Do not drop or push anything into any slot of the machine. Please stop immediately and consult your doctor if you feel unwell when using this machine. Not intended for use by persons (including children) with reduced physical, sensory or mental capabilities, or lack of experience and knowledge, unless supervised. Do not use if you are pregnant, unwell, or have a pre-existing medical condition. Do not sit on the back, armrest, or the leg rest as it may result in damage or injury. Do not press or put your hands into the cloth cover of the massage hands.